

TOPKIT MD 235

LEC 6

POTAIN  [®]



Mats - Maste - Masts - Mástil - Torre

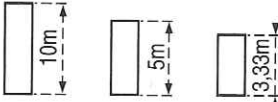

□ 1,6m
MD 235 G12

Flèche - Ausleger - Jib
Flecha - Braccio
25m → 55m

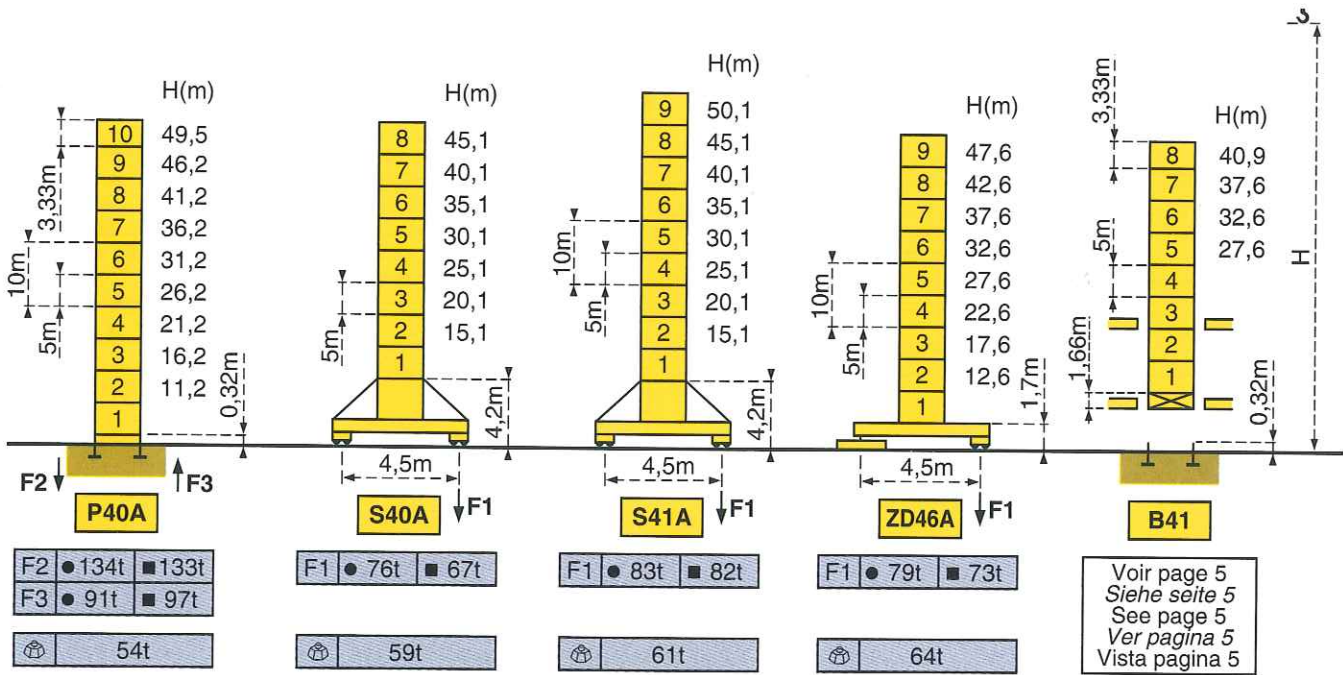

Voir page 5
Siehe Seite 5
See page 5
Ver pagina 5
Vista pagina 5

Mats - Maste - Masts - Mástil - Torre

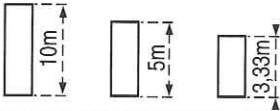

□ 2 m
MD 235 J12

Flèche - Ausleger - Jib
Flecha - Braccio
25m → 65m

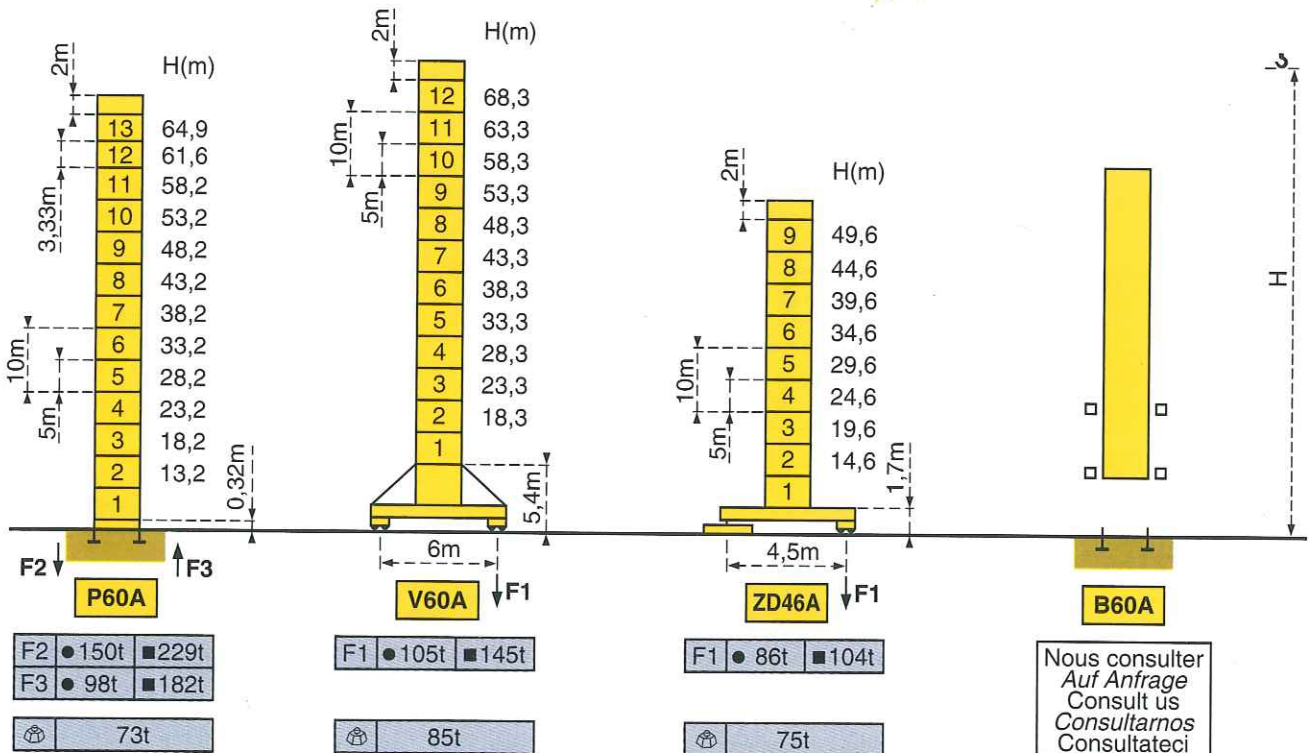

Nous consulter
Auf Anfrage
Consult us
Consultarnos
Consultateci

F = Réactions - Eckdrücke - Reactions - Reacciones - Reazioni

Flèche
Ausleger
Jib
Flecha
Braccio

Courbes de charges - Lastkurven - Load diagrams - Curvas de cargas - Curve di carico

	12,7	15	17	20	22,3	24,6	27	30	32	35	37	40	42	45	47	50	52	55	57	60	62	65	m
65m	12	9,9	8,5	7	6	6	5,4	4,7	4,4	3,9	3,7	3,3	3,1	2,85	2,69	2,47	2,34	2,16	2,06	1,91	1,82	1,7	t
60m		15,3	17	20	22	25	26,9	29,6	32	35	37	40	42	45	47	50	52	55	57	60			t
		12	10,6	8,7	7,8	6,6	6	6	5,5	4,9	4,6	4,2	4	3,6	3,4	3,2	3	2,80	2,67	2,5			
55m			16	20	22	25	27	28,3	31,2	35	37	40	42	45	47	50	52	55					t
			12	9,3	8,2	7	6,4	6	6	5,2	4,9	4,5	4,2	3,9	3,7	3,4	3,2	3					
50m				16,8	20	22	25	27	29,7	32,7	35	37	40	42	45	47	50						t
				12	9,8	8,7	7,5	6,8	6	6	5,5	5,2	4,7	4,5	4,1	3,9	3,6						
45m					17,4	20	22	25	27	30	30,8	33,9	37	40	42	45							t
					12	10,2	9,1	7,8	7,1	6,2	6	6	5,4	5	4,7	4,3							
40m						17,6	20	22	25	27	30	31,1	34,2	37	40								t
						12	10,3	9,2	7,9	7,2	6,3	6	6	5,5	5								
35m							17,6	20	22	25	27	30	31,1	34,2	35								t
							12	10,3	9,2	7,9	7,2	6,3	6	6	5,85								
30m								17,6	20	22	25	27	30										t
								12	10,3	9,2	7,9	7,2	6,3										
25m									17,7	20	22	25											t
									12	10,4	9,2	7,9											

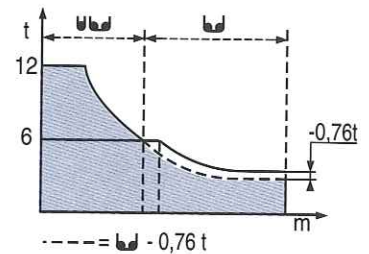

Ancrages - Verankerungen - Anchorages - Anclaje - Ancoraggio

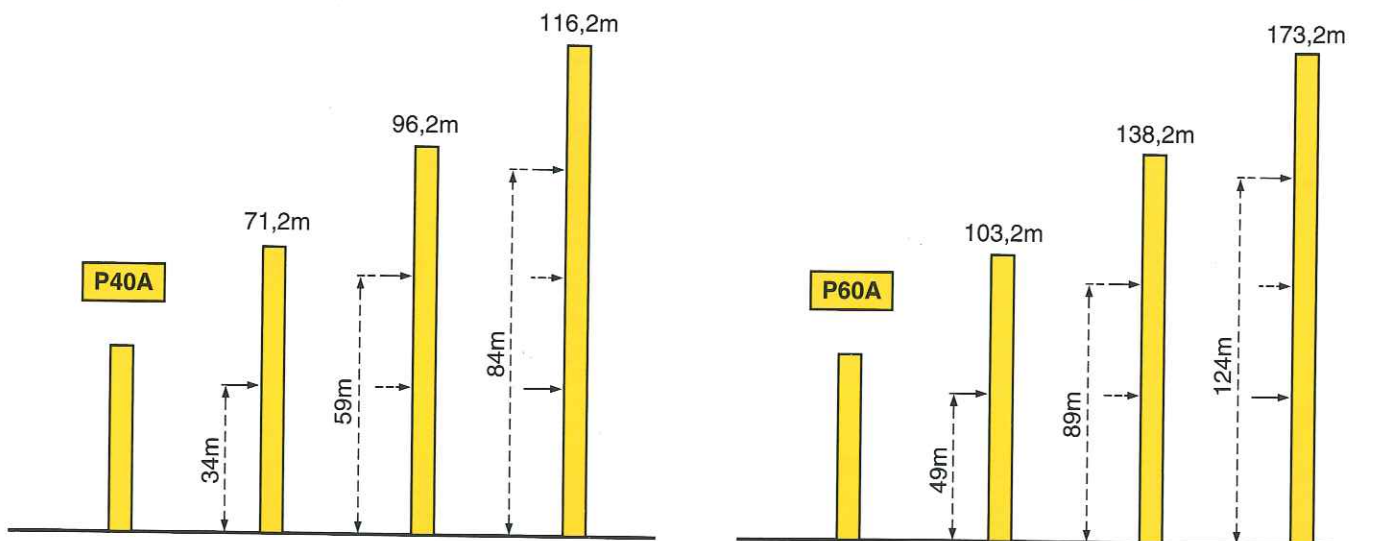

● En service
■ Hors service

● In Betrieb
■ Ausser Betrieb

● In service
■ Out of service

● En servicio
■ Fuera de servicio

● In servizio
■ Fuori servizio

⊗ A vide sans lest
avec flèche et hauteur
maximum.

⊗ Ohne Last und Ballast
mit Maximalausleger und
Maximalhöhe.

⊗ Without load and
ballast with longest jib
and maximum height.

⊗ Sin carga, sin
lastre con flecha y
altura máxima.

⊗ A vuoto senza zavorra
e con braccio massimo e
altezza massima.

Lest de contre-flèche - Gegenauslegerballast - Counter-jib ballast
Lastre de contra flecha - Contrappeso

			(kg)
A	65m	14,5m	21 000 = (5x4200)
	60m	14,5m	20 300 = (4x4200)+(5x700)
	55m	14,5m	18 900 = (4x4200)+(3x700)
	50m	12m	23 100 = (5x4200)+(3x700)
	45m	12m	20 300 = (4x4200)+(5x700)
	40m	12m	18 200 = (4x4200)+(2x700)
B	35m	12m	15 400 = (3x4200)+(4x700)
	30m	12m	13 300 = (3x4200)+(1x700)
	25m	12m	10 500 = (2x4200)+(3x700)

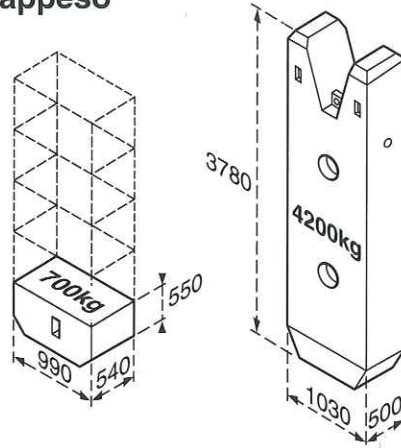

Lest de base - Grundballast - Base ballast - Lastre de base - Zavorra di base

H(m)	A	B	H(m)	A	B	H(m)	A	B	H(m)	A	B	H(m)	A	B			
									68,3	120t	120t						
									63,3	84t	96t						
									58,3	60t	72t						
			50,1	60t	66t	47,6	50t	60t	53,3	48t	48t	49,6	65t	65t			
45,1	60t	66t	45,1	60t	66t	42,6	50t	60t	48,3	24t	36t	44,6	55t	55t			
40,1	60t	66t	40,1	60t	66t	37,6	50t	60t	43,3	24t	36t	39,6	55t	55t			
35,1	60t	66t	35,1	60t	66t	32,6	50t	60t	38,3	24t	36t	34,6	55t	55t			
30,1	60t	66t	30,1	60t	66t	27,6	50t	60t	33,3	24t	36t	29,6	55t	55t			
25,1	60t	66t	25,1	60t	66t	22,6	50t	60t	28,3	24t	24t	24,6	55t	55t			
20,1	60t	66t	20,1	60t	66t	17,6	50t	60t	23,3	24t	24t	19,6	55t	55t			
15,1	60t	66t	15,1	60t	66t	12,6	50t	60t	18,3	24t	24t	14,6	55t	55t			
S 40 A <•>			S 41 A <•>			ZD 46 A <•>			V 60 A <•>			ZD 46 A <•>					
□ 1,6m						□ 2m											

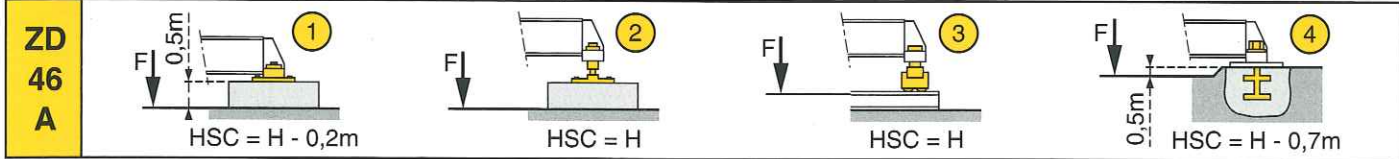

Télescopage sur dalles - Kletterkrane im Gebäude - Climbing crane
Telescopage gruas trepadoras - Gru in cavedio

Mât de 2m : nous consulter
 Mast von 2m : Auf Anfrage
 2 m mast : consult us
 Mástil de 2m : consultarnos
 Torre 2m : consultateci

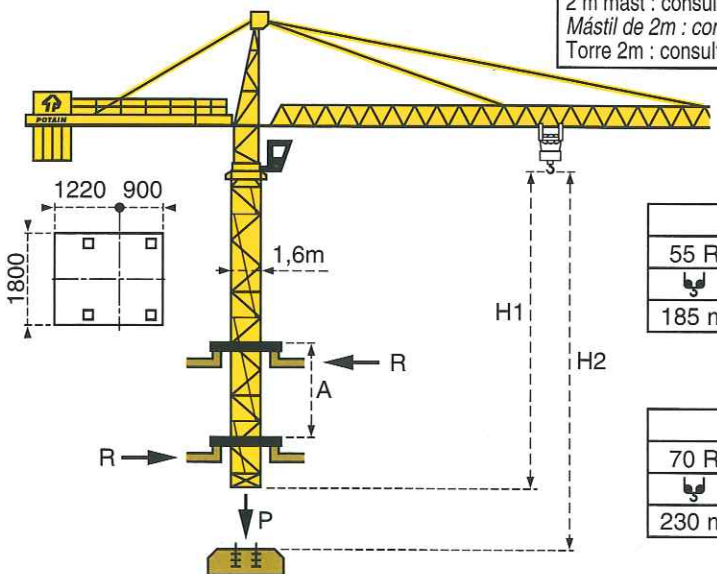





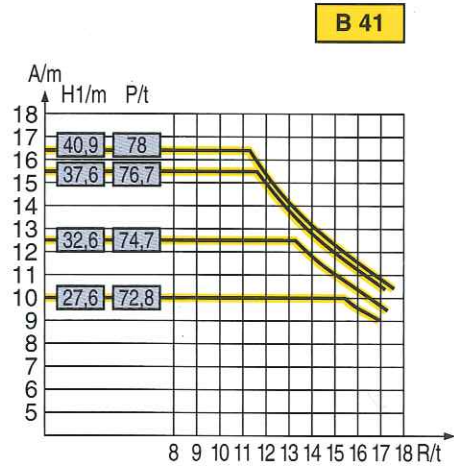





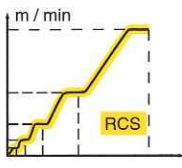

H2	
55 RCS 30D	
185 m	92 m

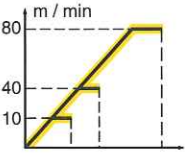
H2	
70 RCS 30D	
230 m	115 m

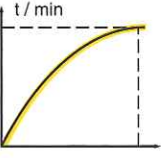

- | | | | | |
|---------------------------------|-------------------------------|-----------------------------|---------------------------------|--------------------------------|
| A Distance entre cadres | A Abstand zwischen den Rahmen | A Distance between collars | A Distancia entra marcos | A Distanza fra i telai |
| H1 Hauteur grue | H1 Kranhöhe | H1 Crane height | H1 Altura grúa | H1 Altezza gru |
| P Poids de la grue (en service) | P Krangewicht (in Betrieb) | P Crane weight (in service) | P Peso de la grúa (en servicio) | P Peso della gru (in servizio) |
| R Réaction horizontale | R Horizontalkräfte | R Horizontal reaction | R Reaccion horizontal | R Reazione orizzontale |

Mécanismes - Antriebe - Mechanisms - Mecanismos - Meccanismi

			m/min	t	m/min	t		ch -PS hp	kW	
Levage Heben Hoisting Elevación Sollevamento		 12t					370m >370m*	55	40,5	
			55	0 → 34	6	0 → 17				12
			RCS	0 → 68	3	0 → 34				6
			30D							
Distribution Katzfahren Trolleying Distribución Distribuzione			6 D3 V4		10-40-80		6	4,4		
Orientation Schwenken Slewing Orientación Rotazione			RCV 185		0 → 0,8 tr/min rpm		2x9	2x6,6		
Translation Kranfahren Travelling Traslación Traslazione	∅ 1,6 m	S 40 A  R ≥ 10m	RT 324	12,5 - 25			2x7	2x5,2		
			TCV 449 ARC H ≤ 35,1m	10 - 50			4x6,8	4x5		
		S 41 A  R ≥ 10m	RT 443 A1 2V	15 - 30			4x5	4x3,7		
			TCV 449 ARC H ≤ 35,1m	10 - 50			4x6,8	4x5		
	∅ 2 m	ZD 46 A  R ≥ 10m	RT 443 A1 2V	15 - 30			4x5	4x3,7		
			RT 544 A1 2V	13,5 - 27			4x7	4x5,2		
		V 60 A  R ≥ 13m	TCV 649 ARC H ≤ 43,3m	10 - 50			4x6,8	4x5		
Réseau - Netzstrom - Mains supply - Red - Rete elettrica							CEI 38 IEC 38	400V(+6%-10%) 50 Hz		
Puissance électrique nécessaire - Anschlusswert - Necessary electric power Potencia eléctrica necesaria - Potenza elettrica necessaria							55 RCS : 80KVA 70RCS : 105KVA			
Groupe électrogène - Stromaggregat - Generator set - Grupo electrogeno - Gruppo elettrogeno							*			

*Nous consulter - Auf Anfrage - Consult us - Consultarnos-Consultateci

Conforme aux directives CEE 84/534 et 87/405 sur le niveau acoustique - Gemäss EWG-Richtlinien 84/534 und 87/405 für den Schall- Leistungspegel
 In compliance with the EEC 84/534 and 87/405 Instructions on noise level - Conforme con las directivas CEE 84/534 y 87/405 sobre el nivel acustico
 Conforme alle direttive CEE 84/534 e 87/405 sul livello acustico

